

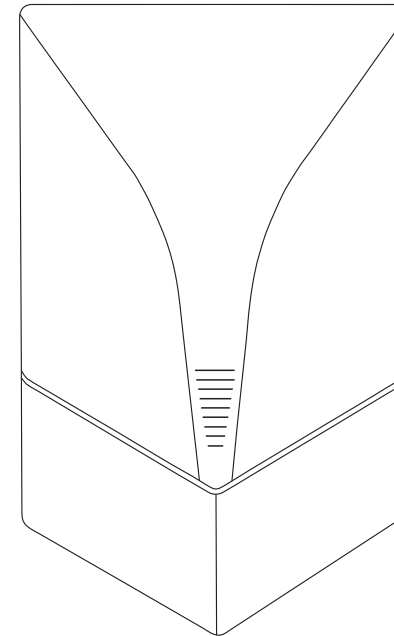

Dolphy Australia  
The sign of quality

**Operation Instruction**  
**Automatic High-speed Hand dryer**

**DAHD0055**



- Thank you for purchasing out Automatic High-speed Hand dryer
- Please read this manual carefully before you use it
- Please keep this maunal propegly for the reference in the future

## Directory table

---

Security Notice Items.....1	BEFORE
Characteristics.....2	
Name of Component.....2	USAGE
Characteristics.....3	INSTALL
Name of Component.....3	
Installation methods.....4-5-6	USAGE
Usage and Attention.....7	MAINTEN
Maintenance.....8-9	
Technical Parameters.....10	OTHERS
Before commission maintenance .10	

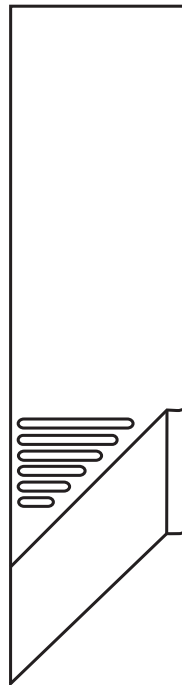

## Usage and Attention

1 Please Power "ON"

2 It is convenient to make operation such as starting only by stretching out hands and stopping only by taching back hand.

Drying hands effectively and promptly

refer following operation

1 Up the bank of your hands unbent your finger, stretch hand under the Air outlet until your finger close to the wall.

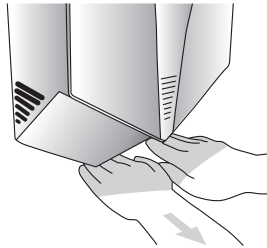

2 When the air/wind out, please forward and backward your hand slowly for times  
※ The Nearer to Air-outlet, more quick for drying.  
※ Attention, the different drying operation, may splash the water

3 Then up the palm of the hand, forward and backward your hands slowly for times.



4 Rub your hands at last.

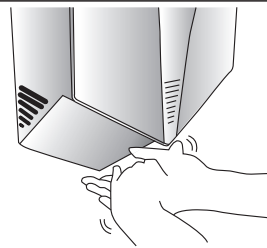

※The machine shut down by itself after continuum operation for 60s. Please taking back hands first, then stretching out hands again, the machine will start automatically.

## Installation methods

### Notice before Installation

**WARNING** Electric matters should be operated by the professional electrician according to the national regulations.  
Please install leakage circuit break to protection against electronic shocks.

■ Please use the leakage circuit break which rated power is 10A,AC110-130V /220-240V,50/60HZ.

### Operation methods of direct power

#### 1 Burying the switch box to arranging wires

- Bury the switch box into the wall, connect the wire (using 600V insulative wire:VVFΦ1.6-Φ2.0,single wire)  
※when use 600V insulative wire ( multiple wire),please press the cover to the wire tightly first, then connect to the power.
- The center location of the switch box is described as following  
(※ the installation hole of the metal installation board is 1260mm away from the ground)  
Height.....1100mm from the ground.Level.....67mm on the right from the metal installation board.
- The length of the wire off the wall is about 300mm.

#### 2 Installation of the metal board.

**NOTICE** please fix the machine firmly on the wall to avoid damage

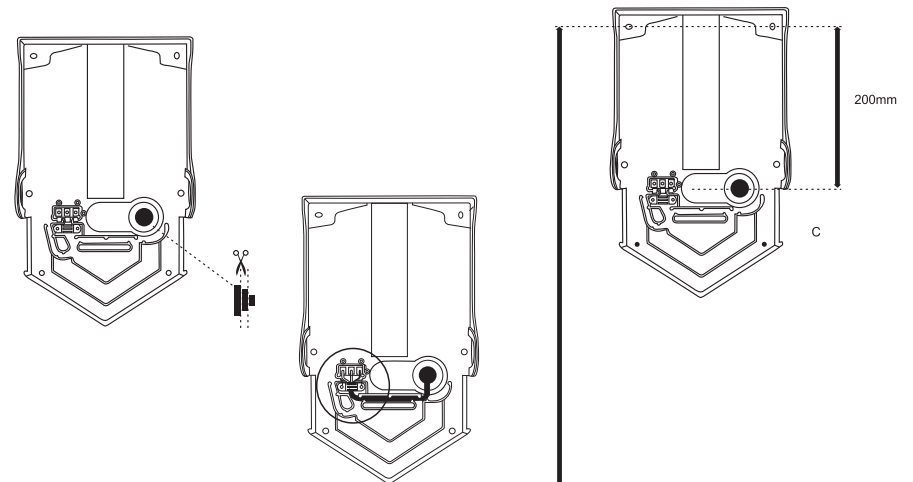

### 3 Installation of the main body

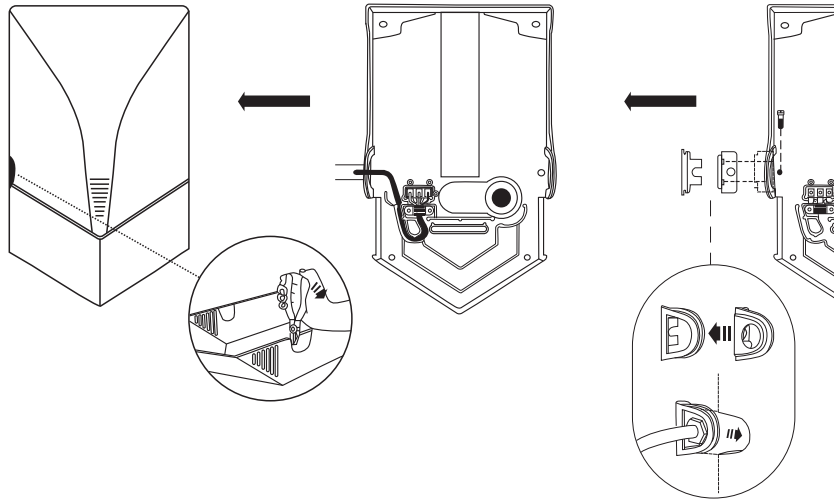

Schematic diagram on the left

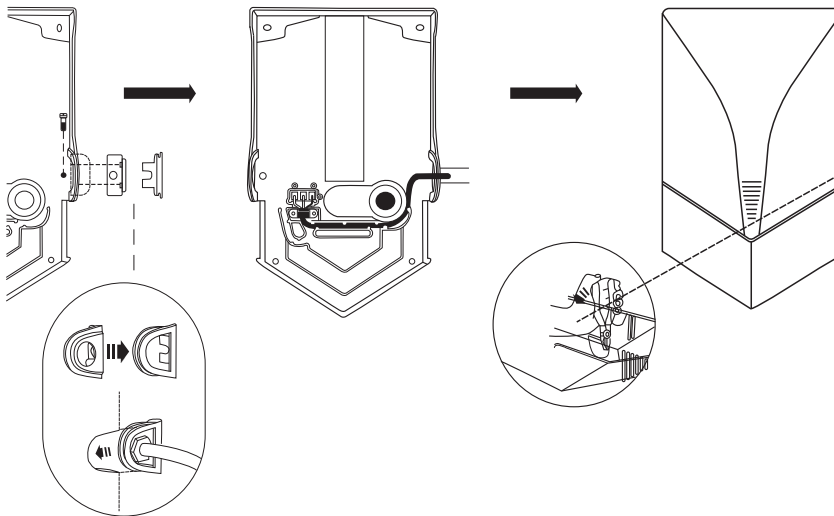

Schematic diagram on the right

### 4 Power installation method

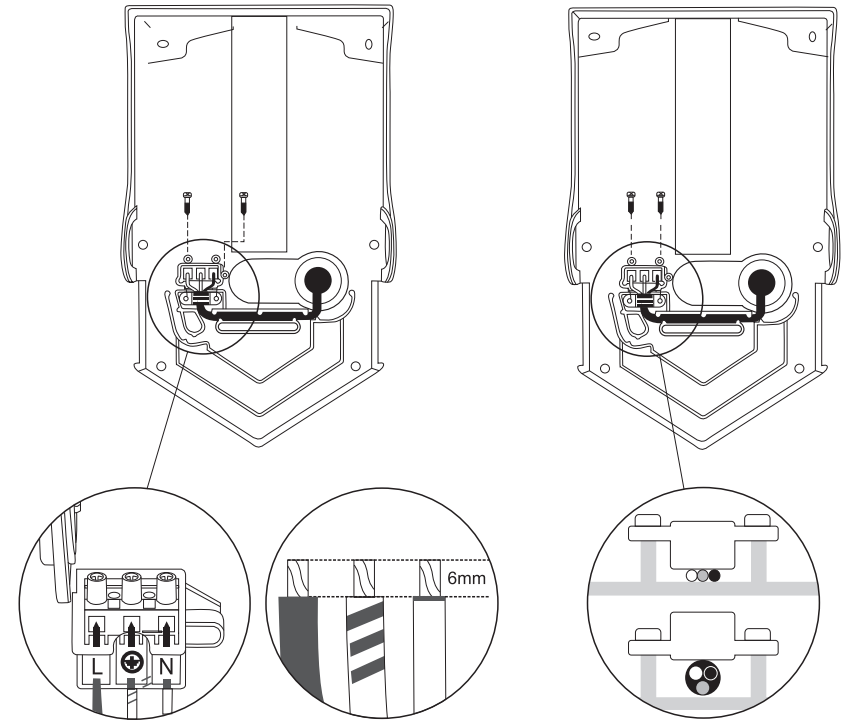

■ After installation, test according to the following methods:

1. Power source
  - After successful installation, plug in the power supply.
3. Confirmation of operation
  - Put your hands at the Air outlet to make sure the air / wind is blowing.

■ After test

- After test, please give the instruction on the customers and explain it clearly to them.

## Technical Parameters

Item	Specification
Model	
Rated voltage	AC 110-130V / 220-240V, 50/60HZ
Rated power	1000W
Motor	AC Brush-shape Motor
Fan	Turbo fan
Protective device	Temperature fusa, thermostat, over current fuse
Working condition	0~40°C
Size (mm)	241X14X395 mm
Weight (kg)	3.3kg
Water reception box capacity	700ml

※ The motor life is 7 years (Brush abrasion)if use 250 times per day. when the motor end life, the air can t out.

## Before Commission Maintenance



Don't decompose, repair and transform privately, or else it might cause electric shock, fire and etc.



Eor following phenomenon, please according this form to check and fix it.

Phenomenon	check and fix
Stretch out hand, But no air out	<ul style="list-style-type: none"> <li>● Is the induction device dirty?</li> <li>→ Please use soft cloth to smear it</li> </ul>
Tacking back hand, But air not stop.	<ul style="list-style-type: none"> <li>● Is the induction device dirty?</li> <li>→ Please use soft cloth to smear it</li> </ul>
The air volume smaller.	<ul style="list-style-type: none"> <li>● Is the filer pack dirty?</li> <li>→ Please cleaning the filter pack.</li> </ul>

## Security Notice Items

Please read the following "security Notice Items" before use, to get a correct guide of using.

For security reasons please use this product correctly to avoid physical injury or economic loss. Please refer to the following explaining of the signal for this manual.

**Warning** Misinstallation may cause casualty if the "Security Notice" is ignored.

**Notice** Misinstallation may cause physical injury or economic loss if this "Security".

Pay attention to the following sings and their signification.



Forbidden



No decompose



Must perform



Forbidden to use your hands or other matters to block up the air outlet, or put extension matters like iron wire into the air outlet. Otherwise the electrical shock or failure will be occured.



Forbidden to splash water into the machine while maintenance, Otherwise the electrical shock or failure will be occured.



Forbidden to decompose, repair or reassemble the machine, To avoid electrical shock or fire accident etc.



Don't put ignited articles like cigarettes on the machine To avoid burn the shell or catch fire.



Please don't hold the machine down. It may cause physical injury or damage of the machine if it falls



During maintaining, make sure the power switch is OFF, Or extra operation may be caused.



## Characteristics

- The machine will work automatically when stretching out your hands at the Air outlet, It's convenient and sanitary as you don't need to touch the machine.
- It will stop working automatically after sixty-second continuous operation, which avoids extra continuous misoperation caused by people on purpose or the machine itself. The machine will resume when the misoperation banished.

## Name of Component

### The main body of hand dryer

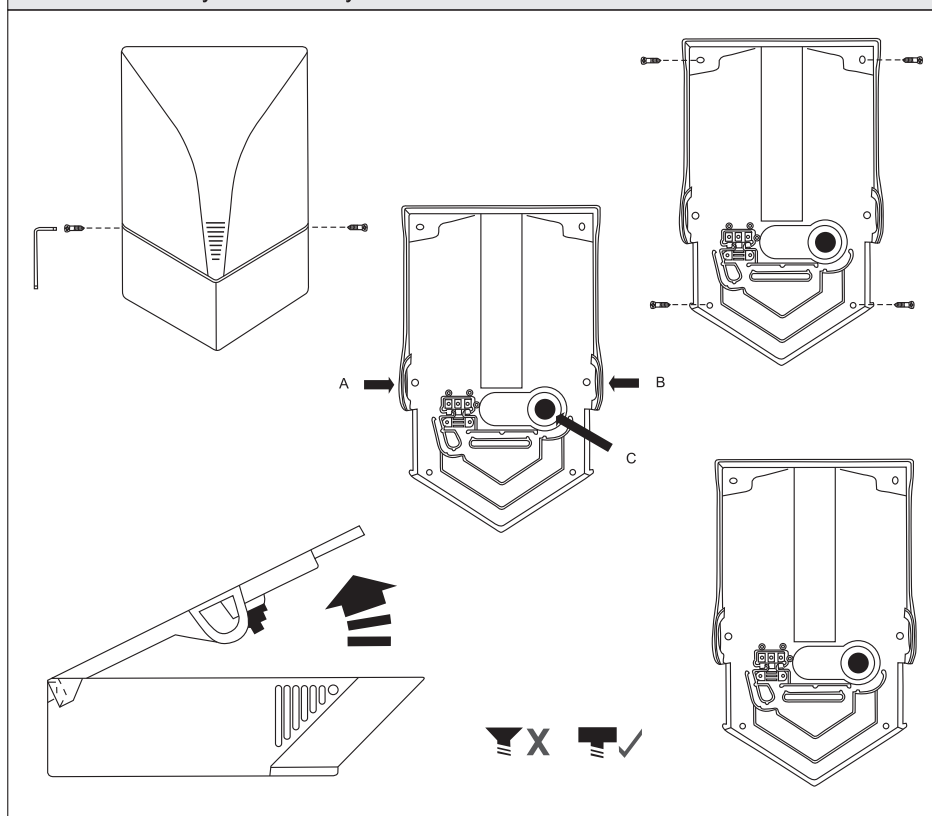

## Maintenance

WARNING	Not splash water inside of machine when for maintenance. Otherwise it may get an electric shock, malfunction.	
NOTICE	Please off the power for maintenance. Otherwise will be lead fault action.	

### Cleaning dirt

For shell marks, please cut off power first and use soft cloth if so machine is so dirty, please dipped neutral detergent(which for wash dish )to smear then rub-up.

### Once or twice each month



The acid or alkaline detergent in bathroom like benzene, lacquer thinner and abrasives are absolutely not applied. Moreover, you must not use nylon brush or brush broom to smear the apparatus, in order to avoid scratches and lacerations.

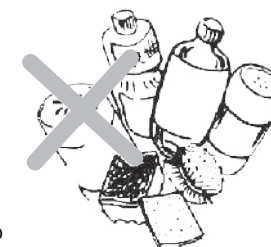

Please use soft cloth to smear it regularly. If have dirt here, it may inductive badly.



Do not use the detergent for this part. (May lead inductive abnormality)

